

Preassembled fixed-point control, distribution and pumping unit for radiant panel heating systems **DOMORADIANT Series**



Main features

DOMORADIANT, is a preassembled module designed for the mixing, pumping and distribution the fluid working in radiant panel heating systems consisting of :

- Central 6-way multifunction valve for mixing of the hot fluid at lower temperature with 3-way mixing valve operated by a thermostatic actuator with positive safety
- Primary flow rate setting device
- Fluid distribution unit for the radiant panel circuits (12 outlets) with manifold DN 1.1/4" side outlets 3/4" eurocone, provided with flow meter
- Fluid distribution unit for the towel radiators (3 outlets) with manifold DN 3/4" side outlets 3/4" eurocone

 **WATTS**[®]
INDUSTRIES

A Division of Watts Water Technologies Inc.

Description

The preassembled unit of the DOMORADIANT Series is designed for modern radiant panel heating systems. It performs all the necessary functions for such purpose, namely:

- providing tight-sealed hydraulic connection of the pipe ends in the various coils making up the radiant panels (CPRFL series); it allows shut-off (if required) and the necessary setting and monitoring of all flow rates
- providing the hydraulic connection for the pipes feeding the towel-rail radiators (807MF series)
- automatic air venting
- mixing of the fluid for the radiant panels and holding it at low temperature
- ensuring the supply and head of the high temperature circuits
- visual temperature monitoring

The device designed for mixing and delivering hot water at the lower temperature consists of a 3-way mixing valve operated by a thermostatic actuator with remote sensor type FH-148SD (range 20-50 °C). The required flow rate for feeding the radiant panels is supplied by a 3-speed electrically driven pump. The manifold can supply up to **12 low temperature circuits** and up to **3 radiators**. Each return outlet is arranged to receive thermostatic actuator series 22C for adjusting the ambient temperature in each individual room. The supply outlet is fitted with flow meter FLMR series able to measure and adjust the flow rate accordingly. **Optionally** the various electrothermic actuators (when provided) can be controlled by a modular control box WFHT series, from 4 to 6 zones through room thermostats.

The Master module is provided with a control relay for the electrically-driven pump which is automatically deactivated when all the actuators are closed. When the actuators are not controlled by the modular box, a by-pass kit is available for controlling the differential pressure. Such kit should be attached to the head connections of the manifolds.

The system, which has been hydraulically tested in the factory, is housed in a special inspection box with single door and with epoxy finishing.



DOMORADIANT - FH01

Preassembled fixed-point control, distribution and fluid pumping unit **for radiant panel heating systems (low temperature)**. The system allows supplying and controlling the individual radiant panel circuits with fluid at lower temperature, which can be set in the range from 20 to 50 °C.

6-way multi-function valve equipped with :

- 3-way mixing valve and built in safety (max 55 °C) through differential Kv
- Thermostatic actuator with remote sensor coupled to 3-way valve
- Integrated hydraulic equalization system
- Calibrated flow meter for setting and display the flow rate
- Auxiliary connections for towel-rail radiators
- Thermometer for primary temperature reading (0-80 °C)
- Shut-off valves

Pumping unit :

- 3-speed electrically-driven pump Grundfos type 25/60 and pipe fittings for connection to the manifold

Distribution unit Including :

- Brass manifolds DN 1.1/4" F , Series 822MM (delivery) and Series FLMR (return) for radiant panel circuits
- Side outlet 3/4" M Eurocone
- Pipe fitting for manifolds complete with thermometer (0-80 °C), float type air vent valve, water drain

Integrated control system (optional and supplied separately) including :

- ON/OFF electrothermic actuators Series 22C
- Modular control box 4/6 zones (Series WFHC), which can be coupled to a weekly programming clock for 2 heating zones
- Electronic room thermostats (Series WFHT) also available in wireless version

Sheet metal inspection box, frame and door, white finishing and of adequate size.

Optional : by-pass kit for checking differential pressure.

Type	Part no.	Panel outlets	Dn panel manifold
FH01	FH010600	n° 6 - 3/4" EUROCONE	1.1/4"
FH01	FH010700	n° 7 - 3/4" EUROCONE	1.1/4"
FH01	FH010800	n° 8 - 3/4" EUROCONE	1.1/4"
FH01	FH010900	n° 9 - 3/4" EUROCONE	1.1/4"
FH01	FH011000	n° 10 - 3/4" EUROCONE	1.1/4"
FH01	FH011100	n° 11 - 3/4" EUROCONE	1.1/4"
FH01	FH011200	n° 12 - 3/4" EUROCONE	1.1/4"



DOMORADIANT - FH01-R

Like FH01 but complete with manifolds for supplying towel-rail radiators (n° 3 outlets Dn 3/4") (high temperature).

Type	Part no.	Panel outlets	Dn panel manifold
FH01-R	FH01R0630	n° 6 - 3/4" EUROCONE	1.1/4"
FH01-R	FH01R0730	n° 7 - 3/4" EUROCONE	1.1/4"
FH01-R	FH01R0830	n° 8 - 3/4" EUROCONE	1.1/4"
FH01-R	FH01R0930	n° 9 - 3/4" EUROCONE	1.1/4"
FH01-R	FH01R1030	n° 10 - 3/4" EUROCONE	1.1/4"
FH01-R	FH01R1130	n° 11 - 3/4" EUROCONE	1.1/4"
FH01-R	FH01R1230	n° 12 - 3/4" EUROCONE	1.1/4"



DOMORADIANT - FH01-G

Preassembled control and fluid pumping unit with 6-way multi-function including: primary fluid flow rate setting device, three-way mixing valve **with fixed-point control** through thermostatic actuator with remote probe, **hydraulic equalization device**, thermometer for measuring primary fluid temperature.

Type	Part no.	Description
FH01-G	FH01-G	One model only



DOMORADIANT - FH01-GR

Like FH01-G but complete with manifolds for supplying towel-rail radiators (high temperature).

Type	Part no.	Radiator side outlets	Description
FH01-GR	FH01-GR	n° 3 - 3/4" EUROCONE	One model only

FH-Bypass

By-pass kit for differential pressure control with a straight body valve DN 1/2", pipes and fittings for coupling to the **Series FH** modules

Application

The heating of places by using heat radiating floors is by no means of recent technique; documents and archeological finds have born witness to this type of heating used by Egyptians, Greeks and Romans already over two thousand years ago.

Since then radiant heating has undergone considerable variations; the main one is that of having introduced **the use of water as heat-carrier fluid** instead of the direct use of fire and smoke. Radiant panel heating systems are, for their very nature, systems which guarantee maximum room comfort with low energy consumption. For these reasons, the radiant panel heating system is being used more and more in residential buildings, in the service industry, in the industrial world, and in commerce, institutes, churches, etc. with optimum results.

Laying of the pipework is relatively simple while the need to set the flow rates of the individual panels and therefore their efficiency, requires the use of dedicated devices.

The preassembled **DOMORADIANT** module neatly meets these functions thanks to the 6-way multi-function valve which controls the temperature of the working fluid. With the flow meters installed on each outlet, it ensures great accuracy of the flow rates in the individual panel circuits.

The addition of automatic room temperature control through thermostats which operate noise-free electrotermic actuators, mounted on the low temperature distribution manifold allows a more rational energy use with consequent reduction of energy consumption.

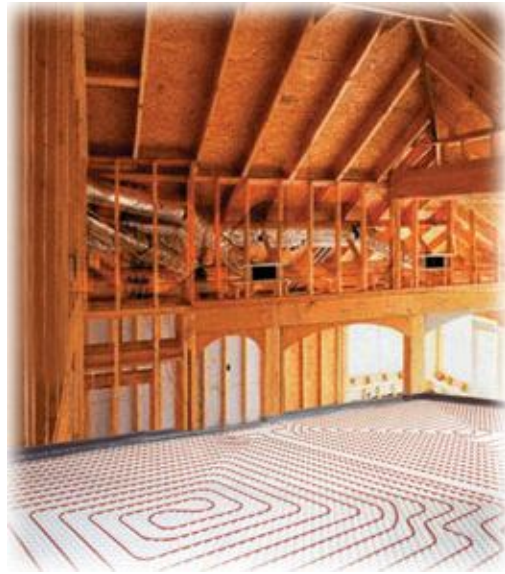

The 6-way multi-function valve (patented)

The multi-function valve is an innovative solution for controlling the underfloor heating system. The hot fluid delivered by the boiler is regulated and made available for the low-temperature supply of the radiant panel circuits thanks to a three-way mixing valve operated by a thermostatic actuator with remote sensor, or diverted directly to the circuits supplying the towel radiators. The multi-function valve is designed to ensure positive safety to the system also in case of failure of the thermostatic actuator.

The special configurations of the internal flow sections determine differential hydraulic characteristics (Kv) in the 3 ways of the mixing valve: max. flow rate with the high temperature primary fluid is always equal to 25% of the total supplied flow rate of the radiant panel heating system, and mixed with the remaining 75% of the low temperature fluid coming from the return circuit of the panels.

This determines a built-in safety for the system and such factor provides the certainty that the service temperature to the panels does not exceed the threshold of 55°C (under nominal operating conditions).

Main advantages such as :

- Low noise during operation, also in the case of failure or malfunctioning of the mixing unit (valve/actuator)
- No need for safety thermostat against overheating. Continuity of service for the user in the case of faulty operation with control locked on fully open position
- Great accuracy of the fluid temperature control system thanks to the different kv values thus drastically avoiding annoying hunting of the valve which would otherwise merely become an ON/OFF type control with continuous trimming of the safety thermostat.

Alternative version of the unit with 3-way mixing valve operated by thermostatic actuator with remote sensor type 148SD

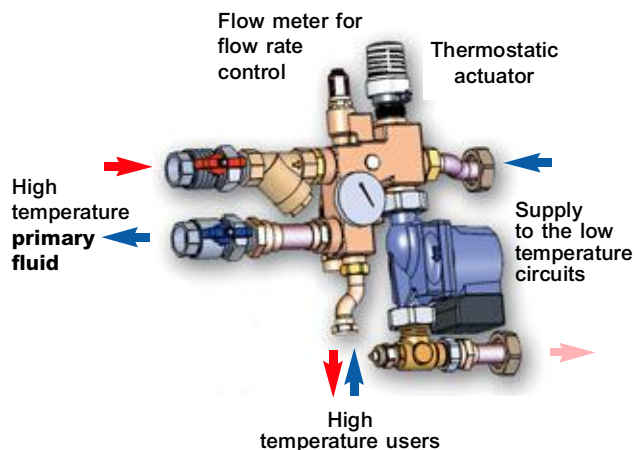

The multi-function valve incorporates the presence of the hydraulic equalization device. This device is really a section connecting the supply and return lines of the primary circuit, between whose nodes the differential pressure is nil or almost so: such indispensable hydraulic precaution avoids any interference effects due to the influence in terms of residual head of the mains pump with the recirculating pump on board the unit.

The standard accessories are complete with a 3-speed electrically-driven pump to provide the flow rate and head necessary for the panel circuits (see residual head graph), a flow meter for displaying and setting of the total design flow rate and a thermometer for direct reading of the primary fluid

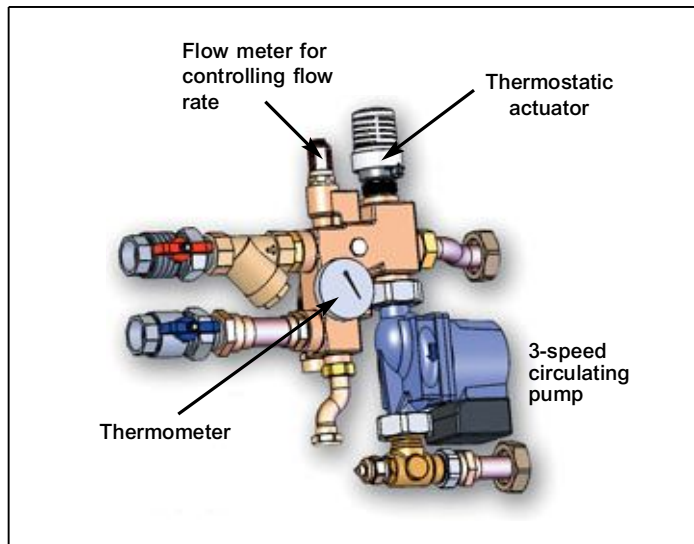

Preassembled manifold for low temperature fluid distribution

The ability to adjust with a high degree of accuracy the flow rates in the various branches to the design value and to yield the correct quantity of energy in the environment, is the performance characteristic which "makes all the difference", above all in radiant panel heating systems, between an ordinary manifold and the preassembled manifold used in the DOMORADIANT module.

The preassembled manifold serving for distribution of the low temperature fluid, allows **setting the flow rate and automatic control of each single circuit** as well as visual checking of the fluid temperature thanks to the following components :

- Modular supply manifolds Series FLMR complete, for each supply outlet, with flow meter (scale 0-6 litres/minute) incorporated in the setting device.
- Modular return manifolds Series 822MM with built-in control valves which can be thermostatted with electrothermic actuators Series 22C (on request)

- End accessory holder (823MP) on the supply and return lines, fitted with float-type manual air vent valve (Series 2161C - Floatvent Dn 3/8"), drain valve (Art. 238), bimetal contact thermometer (Series TBE-63 - Scale 0-80°C)

The manifold unit available with diameter DN 1.1/4" and any number (up to 12) of side outlets DN 3/4" eurocone thread, is assembled with two mounting brackets; when the manifolds are joined well aligned to each other via a lock nut, they ensure a perfectly tight seal thanks to a prefitted O-ring.

It is possible to complete the manifold on the head connections with a by-pass kit; this kit includes a two-way straight body valve, for differential pressure control, which is compulsory when the circuits are controlled by automatic components (electrothermic actuators series 22C).

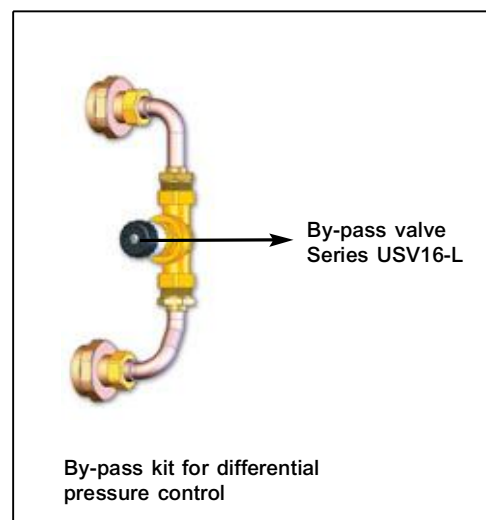
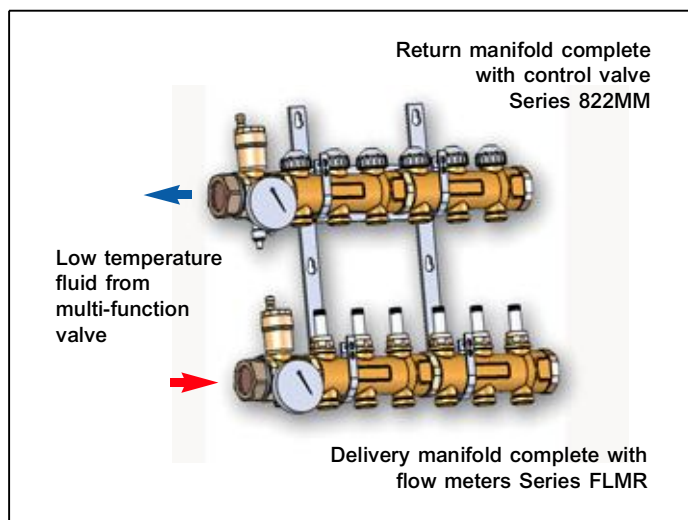

Integrated room temperature control systems

The preassembled DOMORADIANT module is well suited for use of high-tech. solutions which allow improvements in terms of efficiency, energy saving and comfort.

A simple, independently operating system consists in providing the individual supply branches of the panel circuits with electrothermic actuators Series 22C.

The combination does not require any plumbing work; it can also be carried out with the system under pressure; moreover it is noise-free during operation.

The heat emission of the individual panel circuits can be controlled by thermostats (also available in the wireless version) installed in the individual room or pilot zone: the thermostat control either acts directly or can be centralized in a single easy-to-install control module (Series WFHC with 4 or 6 zones).

Communication between thermostats and actuators is through energization of the relay incorporated in the module: up to two 22C actuators can be connected to each relay. Their mode of operation is signaled by a led. This room control can be optimized and made more exact according to the user's requirements if the modular boxes are combined with a programmer timer (Series WFHC-TIMER) which allows inserting different timing programmes and ambient temperature conditions (set-point) subdivided by the panel circuits.

The main modular box of the WFHC Series (called Master) is also provided with a relay for controlling the electrically-driven pump. The secondary module (Slave) has a plug-in connector for easy coupling to the master units whereby control units can be obtained for up to 12 zones.

All control equipment/instruments are supplied separately.

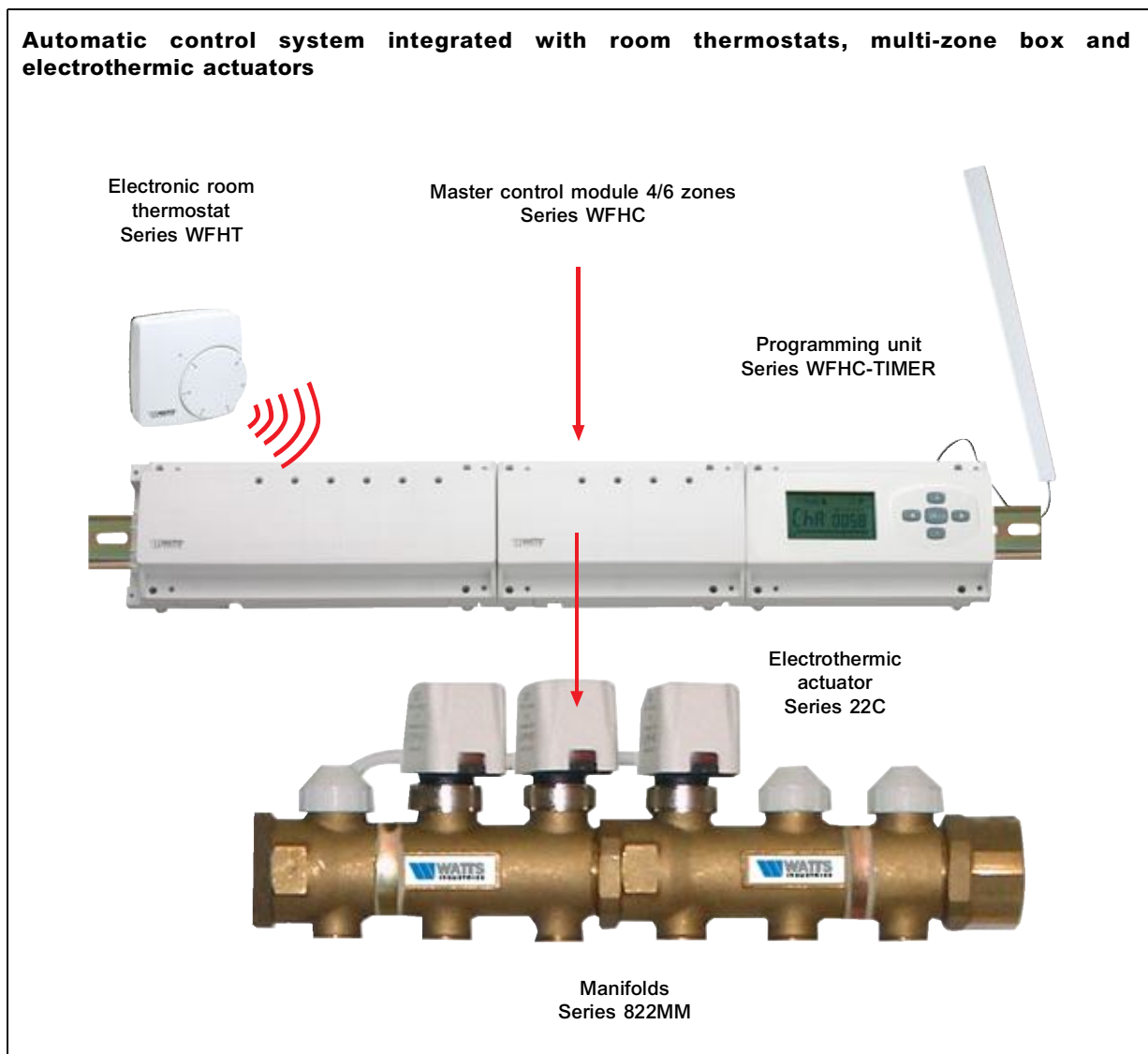

Preassembled high temperature fluid distribution manifold

It is possible to provide the preassembled DOMORADIANT module complete with an independent section for feeding the towel-rail terminal units (conventional radiators, design radiators) which are often necessary in places where the surface available for panel heating is not sufficient (e.g. bathrooms).

In this case, the high temperature primary fluid is diverted to individual brass manifolds Series 807MF, complete with shut-off ball valve.

Manifolds with 3/4" head connection are provided with 3 side outlets size 3/4" eurocone, which easily meet the home users' needs.

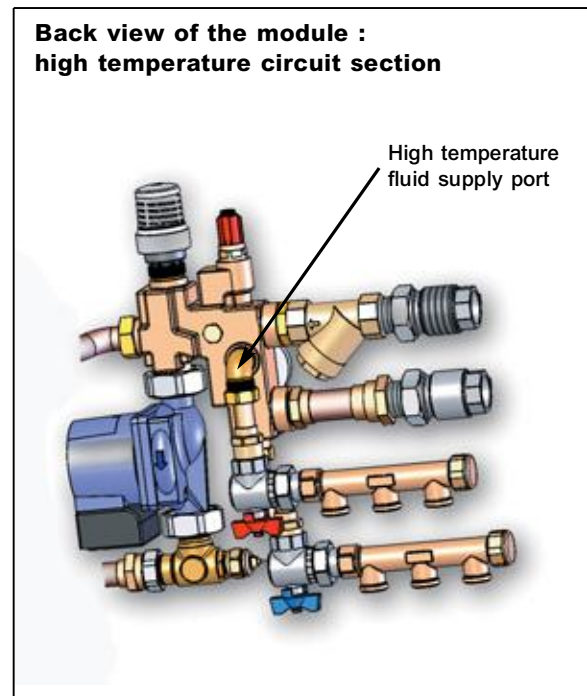
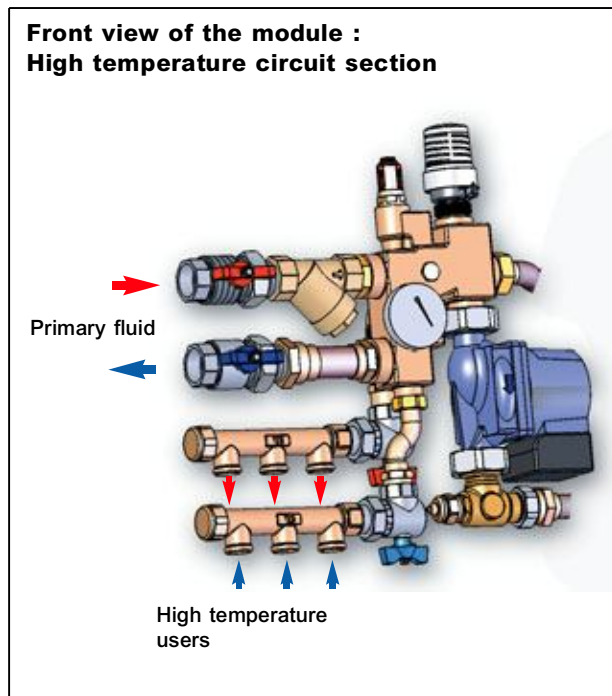

Mode of operation

The special six-way multi-function unit, although very compact in design, controls the module and performs all the main functions as shown in figure 1. Such diagram represents the best fixed-point control circuit with built-in safety, suitable for supplying low temperature systems such as the modern radiant panels in floor heating systems.

The circuit guarantees, with the maximum accuracy, holding the fluid temperature at the required level and conveying the required flow to the radiant panels. At the same time, it allows functioning of the high temperature outlets (for boilers) serving the towel-rail radiators when necessary (bathroom facilities and exposed rooms), so that the entire motive force of the boiler primary pump PP is kept for the latter items.

In order to achieve this, the operating ranges of the two electrically-driven pumps PP and P are held quite separately from the equalization section $x - y$, between whose nodes the different pressure is, as is well known, either zero or almost. This means that pump PP is limited to serving the radiators and node x of the equalization section: while pump P withdraws the very hot water from node x and mixes it with panel return nodes C and B. In order to have a clearer understanding of the efficiency of the system we shall examine what happens when pump P is deactivated. In such case, if the equalization section is shut-off or is missing, the very hot water sent from the boiler by primary pump PP would invade the panels without possibility of mixing; while with the equalization section, it is not possible for the very hot water to reach the panels, rather it will be diverted from node x to node y then it will return to the boiler without any consequences. Basically speaking, flow g at temperature $t1$ will pass downwards via the equalization section while flow gc will be null even if port a of mixing valve VM is fully opened owing to a failure. Hence we have the advantage of being able to suspend the heating to the panels by merely stopping just pump P and here we also have the first built-in safety against over-heating.

Also as regards correct operation, a flow meter VB for the max. flow rate of very hot water is installed upstream of node x . This very hot water is withdrawn directly from the boiler in such a way as to limit to what is strictly necessary (or little more) for the radiant panels ($g = g1$ max is normally $1/4$ of $g3$) by overcoming the differential pressure between $x - y$ at 0, but leaving the flow and head between nodes D to E. If flow meter VB is not used, flow g would be much higher, tending to be equal to gg ; such flow would be discharged in the equalization section

thus determining a serious drop in the residual motive force at nodes D - E and this would cause not sufficient water supply to the radiators. Thanks to this circuit characteristic, the performance levels of the primary pump can also be very high or subject to a certain variability without upsetting the downstream control system protected by equalization section x - y. We shall now examine the mixing section controlled by pump P, valve VM and by-pass AB. In order to have the best effect, three-way mixing valve VM has a flow coefficient which when related to the total panel flow g_3 , represents only 1/4 of it or less (the Kvs value is adjustable).

This means that maximum flow rate of very hot water g_c , represents only 0.25 of g_3 ; while the remaining 0.75 of g_3 involved in the mixture, i.e. g_2 , flows across the return (cold) section of the panels via the calibrated and preset by-pass AB. Thanks to the mixing conditions described above, we can have the certainty that even in the event of any failure, the max. panel supply temperature will be:

$$0.25 \times 80^\circ\text{C} + 0.75 \times 40^\circ\text{C} = 50^\circ\text{C}$$

therefore also remaining within the positive safety limits even without use of any other devices.

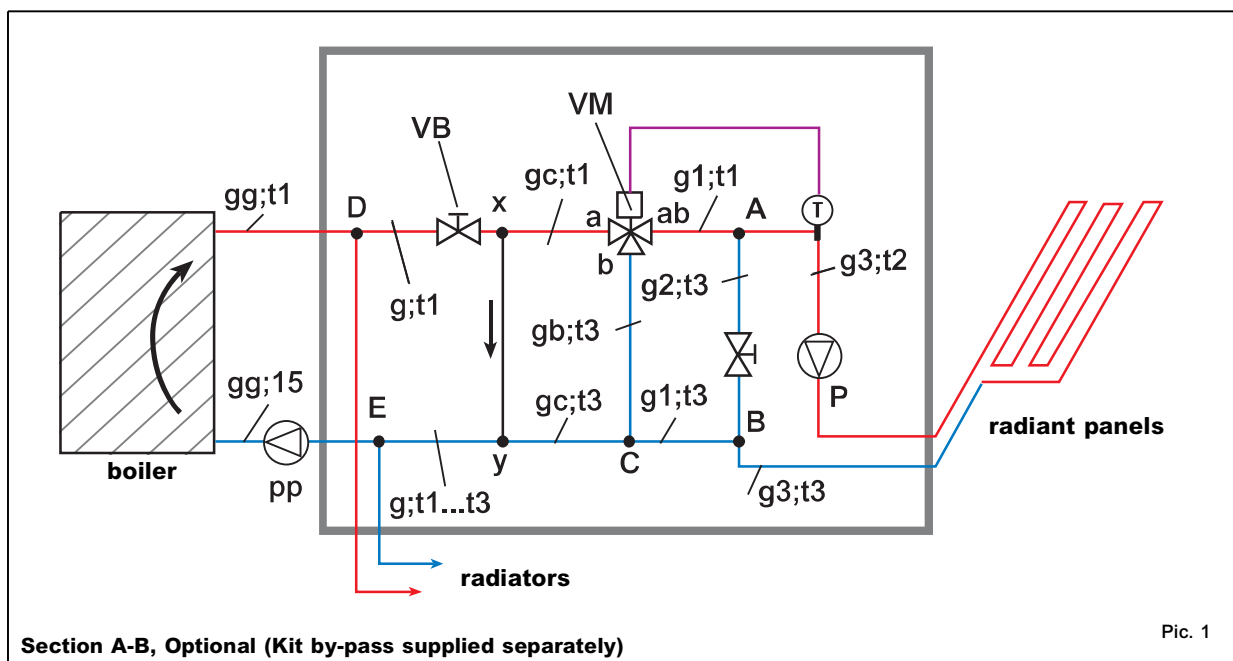

Technical data	
Valve body material, pump connections, manifold	Brass EN12165 CW617N
Max. primary inlet temperature (boiler side)	80 °C
Nominal pressure, entire module	10 bar
Max. operating pressure (depending on piping)	4 bar
Nominal inlet temperature (from boiler)	70 °C
Adjust temperature range, radiant panel	20 - 50 °C
Modulating controller	Proportional Band 10K
Nominal flow rate (3rd pump speed)	1800 l/h
Nominal head to manifold (3rd pump speed)	25 kPa
Power rating (thermal difference ~ 7K)	15 kW
Range of measurement and adjustment, flow meter VB	2-16 l/min (120 to 960 l/h)
Factory setting of flow meter VB	7 l/min. (420 l/h)
Max. temperature which can be reached in the panel circuits in intrinsic safety (system failure, primary temperature 80°C)	55 °C
Max. ratio of primary flow (from boiler)	0.25
Range of measurement/balancing, flow meters. Single panel	1 ÷ 6 l/min. (60 to 360 l/h)
Temperature range, thermometers	20 - 80 °C
Pump centre distance	130mm
Connection to pump	1.1/2"
Connections to manifolds	1.1/4"
Manifold head connection for panels	1.1/4"
DN, panel manifolds outputs	3/4" eurocone
Manifold head connection for radiators	3/4"
DN outlets, radiator manifolds with 3 outlets	3 /4" eurocone

Pump model

With three-speed selector switch and safety thermal overload relay :
supply voltage 230V – 50 Hz, degree of protection IP 44.

Residual head		0.36	0.75	1	1.5	1.75	2	2.5	3.5	3.82
Curve 3	H3 [kPa]	55.04	49.56	44.66	32.73	26.71	19.64	3.87		
Curve 2	H2 [kPa]	42.84	33.16	28.16	14.03	6.71				
Curve 1	H1 [kPa]	21.94	12.56	8.16						

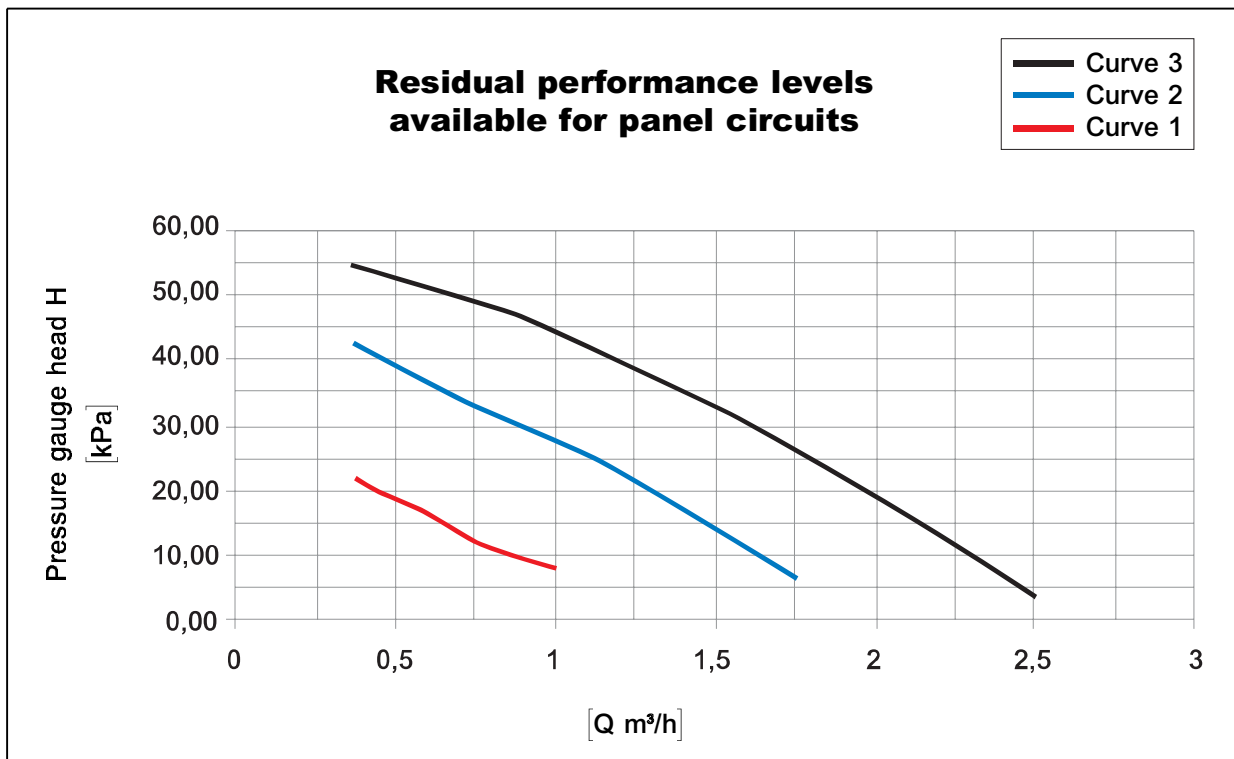

Installation

For installation of the preassembled module DOMORADIANT an inspection box is available, fully made of galvanized metal, in various sizes, depending on the number of side outlets required, and complete with door.

Its compact size (110 mm in depth) makes it easy to embed in the internal partition walling: construction of the system is made easier by removing part of the front frame and side windows.

The module is designed to receive the fluid **from both right and left side** : if necessary the installer can turn the entire module upside-down to adapt it to the inlets on the right-hand side (for such purpose, there are connections at the back of the multi-function valve and on the accessory-holder terminal where to insert the thermometers and connect the supply manifolds of the towel-rail radiators).

The box can include any of the configurations available for the module : the examples given below illustrate three versions with 6 panel circuit connections.

All DOMORADIANT solutions are hydraulically factory tested.

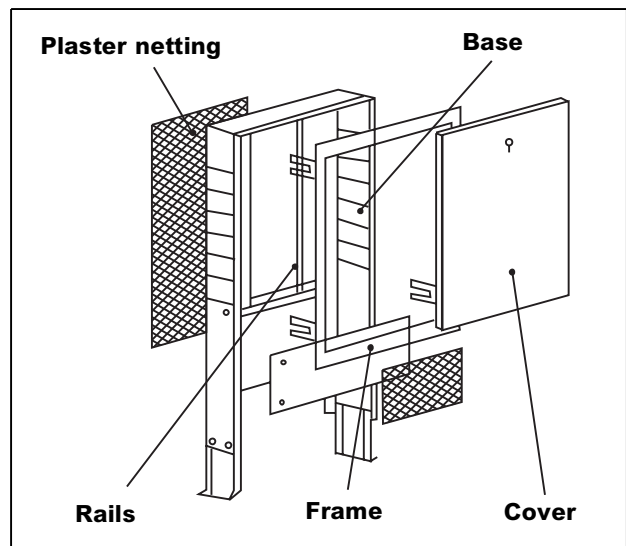

Example preassembled control and fluid pumping unit designed for connecting to the manifolds for distribution low and high temperature fluid (radiant panels and radiator)

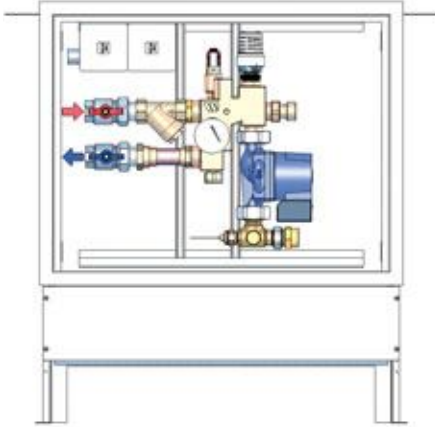

Example of preassembled module with distribution of low temperature fluid for radiant panels

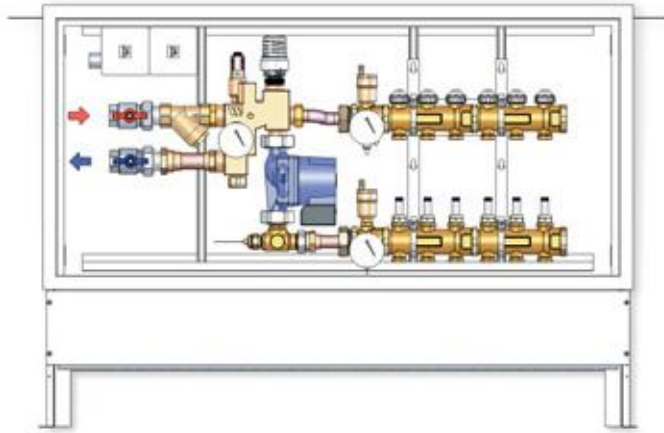

Example preassembled control and fluid pumping unit designed for connecting to the manifolds for distribution low temperature (radiant panels) and complete with distribution manifold for high temperature fluid (radiator)

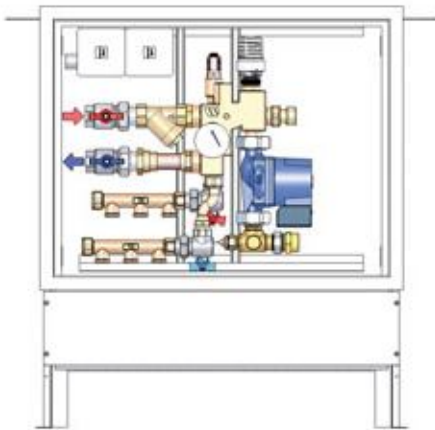

Example of preassembled module in box with independent distribution of low temperature fluid (panels) and high temperature fluid (radiators)

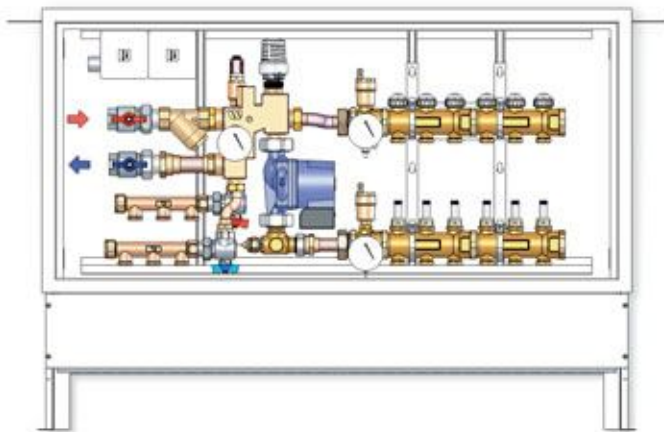

Example of preassembled module in box with independent low temperature fluid distribution. Complete with by-pass circuit.

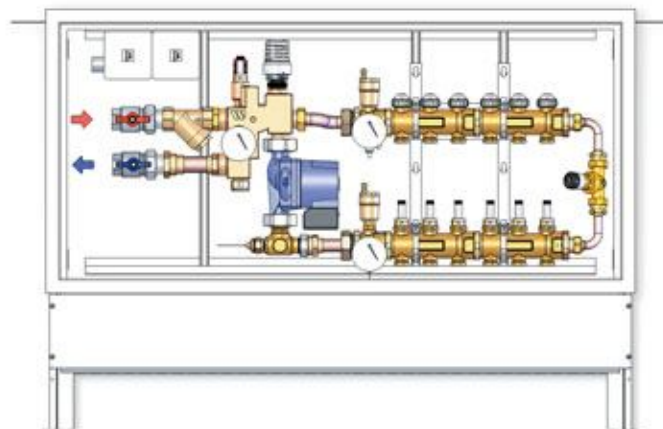

Overall dimensions (mm)

FH01 - FH01-R

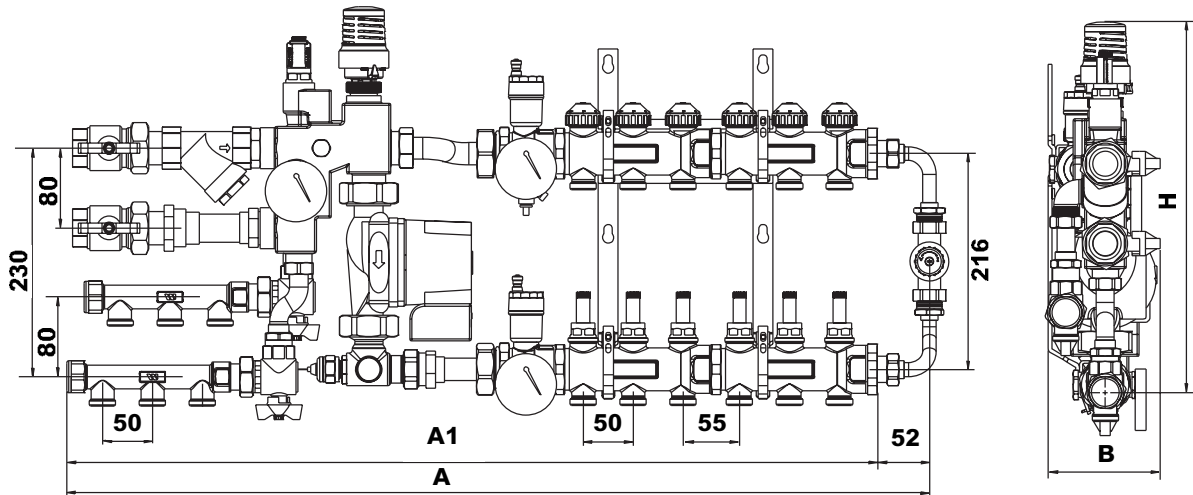

N° of branches (panels)	A	A1	B	H
6	865	813	110	372
7	915	863	110	372
8	965	913	110	372
9	1020	968	110	372
10	1070	1018	110	372
11	1120	1068	110	372
12	1175	1123	110	372

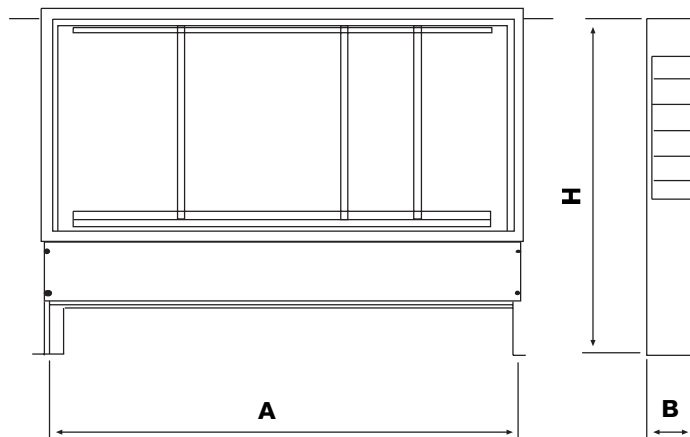

Code	N° of branches (panels)	A	*B	*H
839M10075NV	6-7-8	1000	110/150	720/810
839M12075NV	9-10-11-12	1200	110/150	720/810

* The height and depth of the box can be modified on the spot thanks to the adjustable foot and frame.

Overall dimensions (mm)

FH01-G

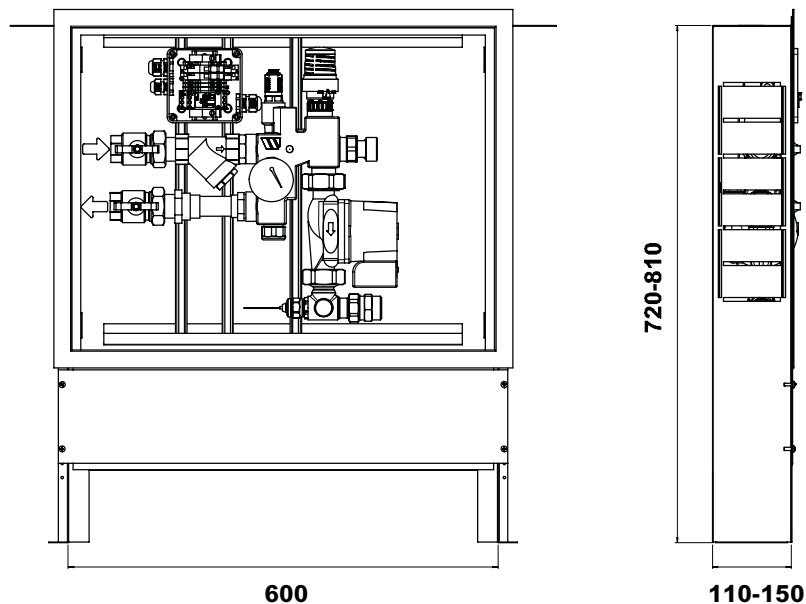

FH01-GR

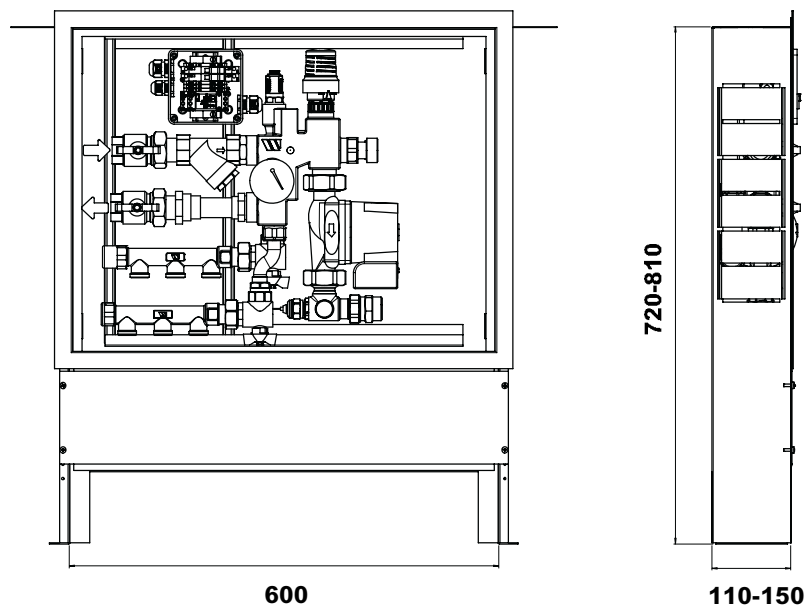

The descriptions and photographs contained in this brochure are supplied by way of information only and are not binding.
Watts Industries reserves the right to carry out any technical and aesthetic modifications to its products without prior notice.



A Division of Watts Water Technologies Inc.

Watts Industries Italia S.r.l.

Via Brenno, 21 - 20046 Biassono (MI), Italy

Ph. : +39 039 49.86.1 - Fax : +39 039 49.86.222

e-mail : info@wattsindustries.it

www.wattsindustries.com